

ESD Protection Diodes

Low Capacitance Bidirectional ESD and Transient Voltage Protection

SD0508D52L SOD523



Description

The SD0508D52L is designed to protect voltage sensitive components from ESD and transient voltage events. Excellent clamping capability, low leakage, and fast response time, make these parts ideal for ESD protection on designs where board space is at a premium.

This device has been specifically designed to protect sensitive components which are connected to data and transmission lines from overvoltage caused by ESD (electrostatic discharge), CDE (Cable Discharge Events), and EFT (electrical fast transients).

Pinout and Functional Block Diagram

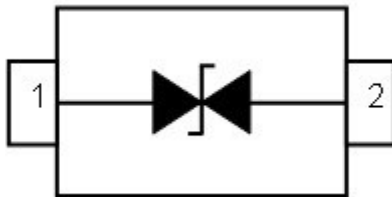

Applications

- Cell Phone Handsets and Accessories
- Notebooks, Desktops, and Servers
- High Speed Line :USB1.0 / 2.0, VGA, DVI, SDI
- Portable Instrumentation
- Protection TV
- Serial and Parallel Ports
- Peripherals

Features

- ESD per IEC 61000-4-2 ± 30 kV (Contact)
- ESD per IEC 61000-4-2 ± 30 kV (Air)
- IEC61000-4-4 (EFT) 40 A (5 / 50 ns)
- Peak Power Dissipation: 75 W (8 / 20 μs)
- Protects One I/O Line
- Low Clamping Voltage
- Low Leakage Current
- Low Capacitance
- High Temperature to Reflow Soldering Guaranteed: 260 °C / 10 sec
- Flammability Rating: UL 94 V-0
- Halogen Free and RoHS Compliant

Order Information

Type	Package	Marking Code	Delivery Form	Delivery Quantity
SD0508D52L	SOD523	5C∞	7" T&R	3000 PCS

Limiting Values

(T_A = 25 °C, unless otherwise specified)

Symbol	Parameter	Conditions	Min	Max	Unit
V _{ESD}	Electrostatic Discharge Voltage	IEC 61000-4-2; Contact Discharge	-	30	kV
		IEC 61000-4-2; Air Discharge	-	30	kV
P _{PP}	Peak Pulse Power (8 / 20 μs)	-		75	W
T _A	Operating Temperature Range	-	-40	150	°C
T _{stg}	Storage Temperature Range	-	-55	150	°C

ESD Protection Diodes

Low Capacitance Bidirectional ESD and Transient Voltage Protection

SD0508D52L SOD523

Electrical Characteristics

($T_A = 25\text{ }^\circ\text{C}$, unless otherwise specified)

Symbol	Parameter	Conditions	Min	Typ	Max	Unit
V_{RWM}	Reverse Working Voltage	-	-	-	5.0	V
V_{BR}	Reverse Breakdown Voltage	$I_T = 1\text{ mA}$	5.6	-	9.0	V
I_R	Reverse Leakage Current	$V_{RWM} = 5\text{ V}$	-	-	1.0	μA
V_C	Clamping Voltage	$I_{PP} = 1\text{ A}$, $t_p = 8 / 20\text{ }\mu\text{s}$	-	-	9.8	V
V_C	Clamping Voltage	$I_{PP} = 5\text{ A}$, $t_p = 8 / 20\text{ }\mu\text{s}$	-	-	15	V
C_J	Junction Capacitance	$V_R = 0\text{ V}$, Measured at 1 MHz	-	-	15	pF

Performance Curve for Reference

($T_A=25\text{ }^\circ\text{C}$ unless otherwise noted)

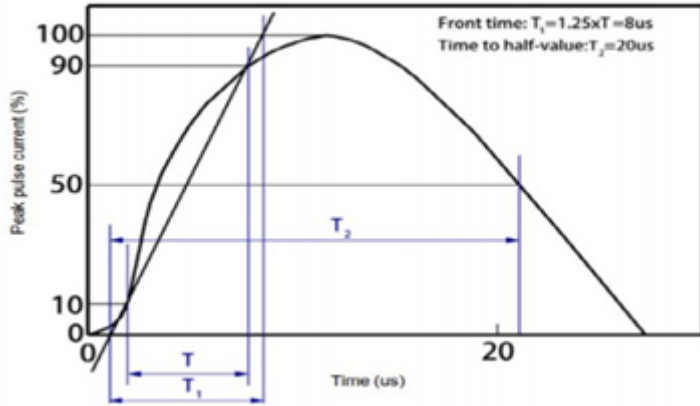

FIGURE 1

8 / 20 μs Waveform Per IEC61000-4-5

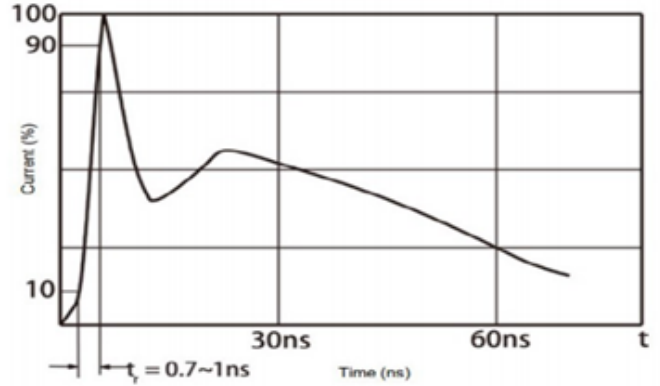

FIGURE 2

Contact Discharge Current Waveform Per IEC 61000-4-2

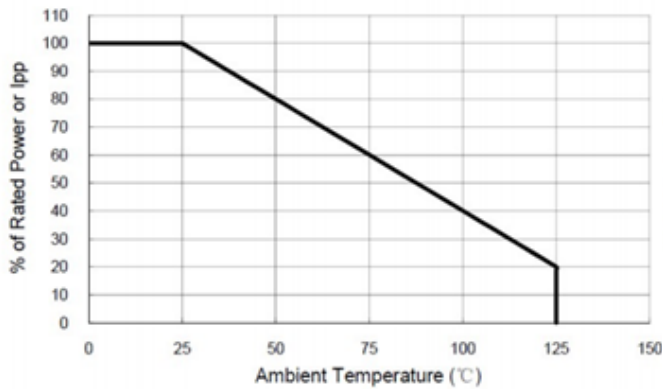

FIGURE 3

Power Derating Curve

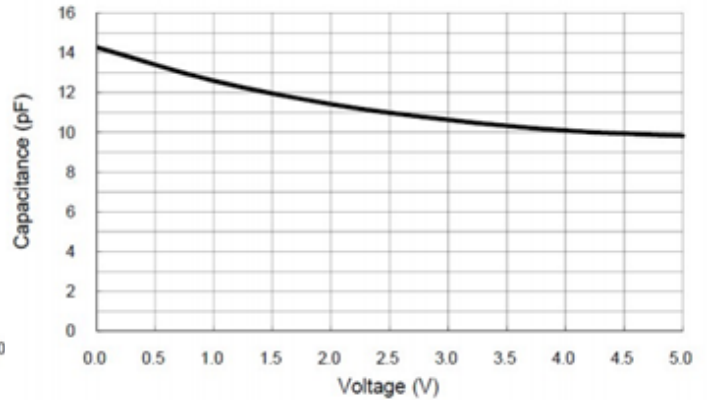

FIGURE 4

Voltage VS. Capacitance

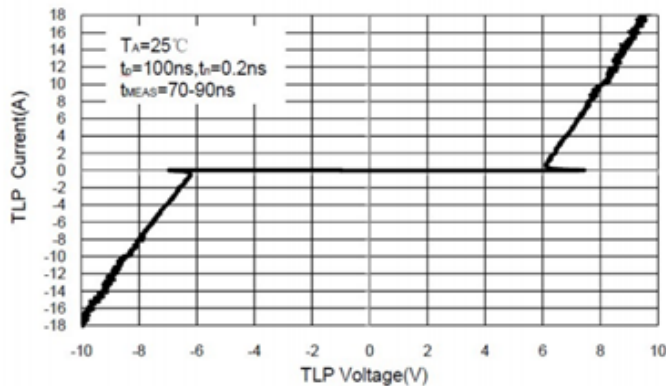

FIGURE 5

Transmission Line Pulsing (TLP) Measurement

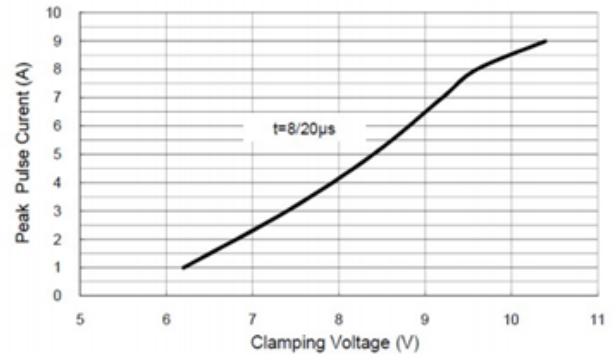

FIGURE 6

Clamping Voltage VS. Peak Pulse Current

ESD Protection Diodes

Low Capacitance Bidirectional ESD and Transient Voltage Protection

SD0508D52L SOD523

Package Dimensions - SOD523

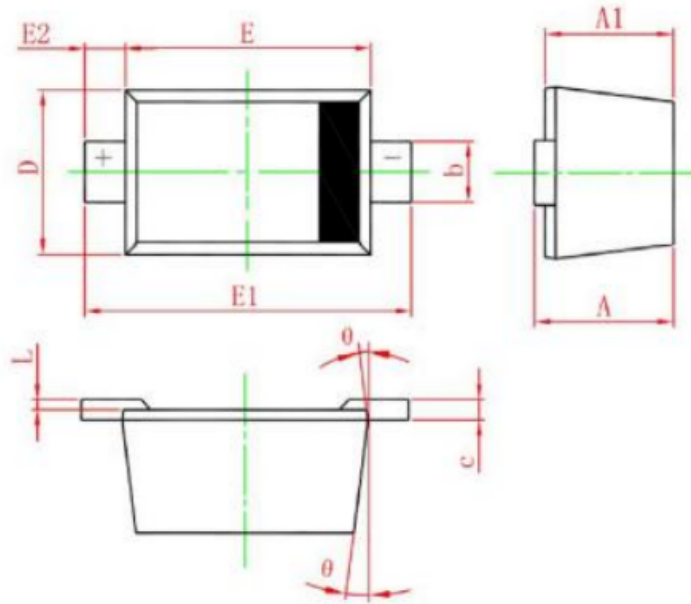

ESD TVS

ESD TVS

Symbol	Millimeters		Inches	
	Min.	Max.	Min.	Max.
A	0.51	0.77	0.020	0.031
A1	0.50	0.70	0.020	0.028
b	0.25	0.35	0.010	0.014
c	0.08	0.15	0.003	0.006
D	0.70	0.90	0.028	0.035
E	1.10	1.30	0.043	0.051
E1	1.50	1.70	0.059	0.067
E2	0.20 REF		0.008 REF	
L	0.01	0.07	0.001	0.003
φ	7 ° REF		7 ° REF	

Soldering Parameters

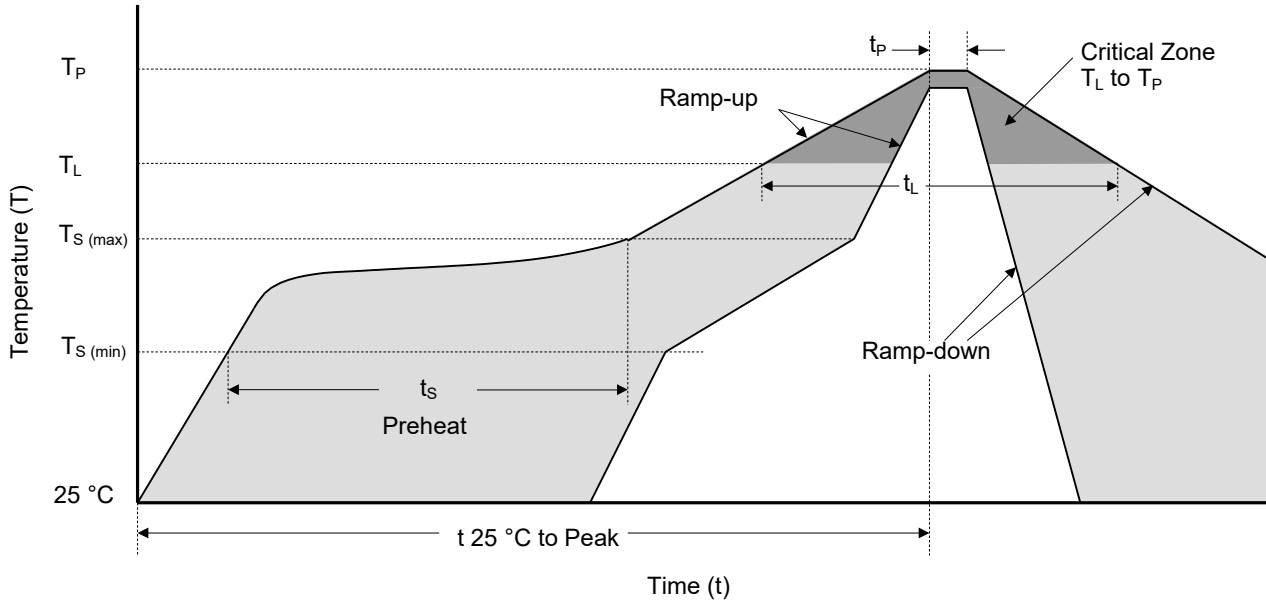

Reflowing Condition

Reflow Soldering Parameters		Lead-Free Assembly
Pre-heat	Temperature Min ($T_{S(min)}$)	150 °C
	Temperature Max ($T_{S(max)}$)	200 °C
	Time (min to max) (t_s)	60 ~ 120 seconds
Average Ramp Up Rate (Liquidus Temp (T_L) to Peak)		3 °C / second max.
$T_{S(max)}$ to T_L Ramp-up Rate		3 °C / second max.
Reflow	Temperature (T_L) (Liquidus)	217 °C
	Time (min to max) (t_L)	60 ~ 150 seconds
Peak Temperature (T_P)		260 ^{+0/-5} °C
Time of within 5 °C of Actual Peak Temperature (t_p)		20 ~ 40 seconds
Ramp-down Rate		6 °C / second max.
Time from 25 °C to Peak Temperature		8 Minutes max.
Do Not Exceed		260 °C

ESD TVS

ESD TVS



ATTENTION

Usage

1. TVS must be operated in the specified ambient temp.
2. Do not clean the TVS with strong polar solvent such as ketone, esters, benzene and halogenated hydrocarbon, to avoid damaging the encapsulating layer.
3. Please do not apply severe vibration, shock or pressure to TVS, to avoid element cracking.

Replacement

1. If TVS is visually damaged, please replace it.
2. TVS is a non-repairable product. For safety sake, please use equivalent TVS for replacement.

Storage

1. Storage Temp. Range: (-55 to 150) °C.
2. Do not store the TVS at the high temp., high humidity or corrosive gas environment, to avoid influencing the solder- ability of the lead wires. The product shall be used up within 1 year after receiving the goods.

Environmental Conditions

1. TVS should not be exposed to the open air, nor direct sunshine.
2. TVS should avoid rain, water vapor or other condition of high temp. and high humidity.
3. TVS should avoid sand dust, salt mist, or other harmful gases.

Max. Typical Capacitance of TVS

1. The typical capacitance of TVS is listed in the specifications. Designers may refer to it when designing TVS in High frequency circuit.

Installation Mechanical Stress

1. Do not knock TVS when installing, to avoid mechanical damage.
2. Please do not apply severe vibration, shock or pressure to TVS, to avoid surface resin or element cracking.